

BM-1600 Rotary Time-Based Brake Monitor

Installation & Operation Manual

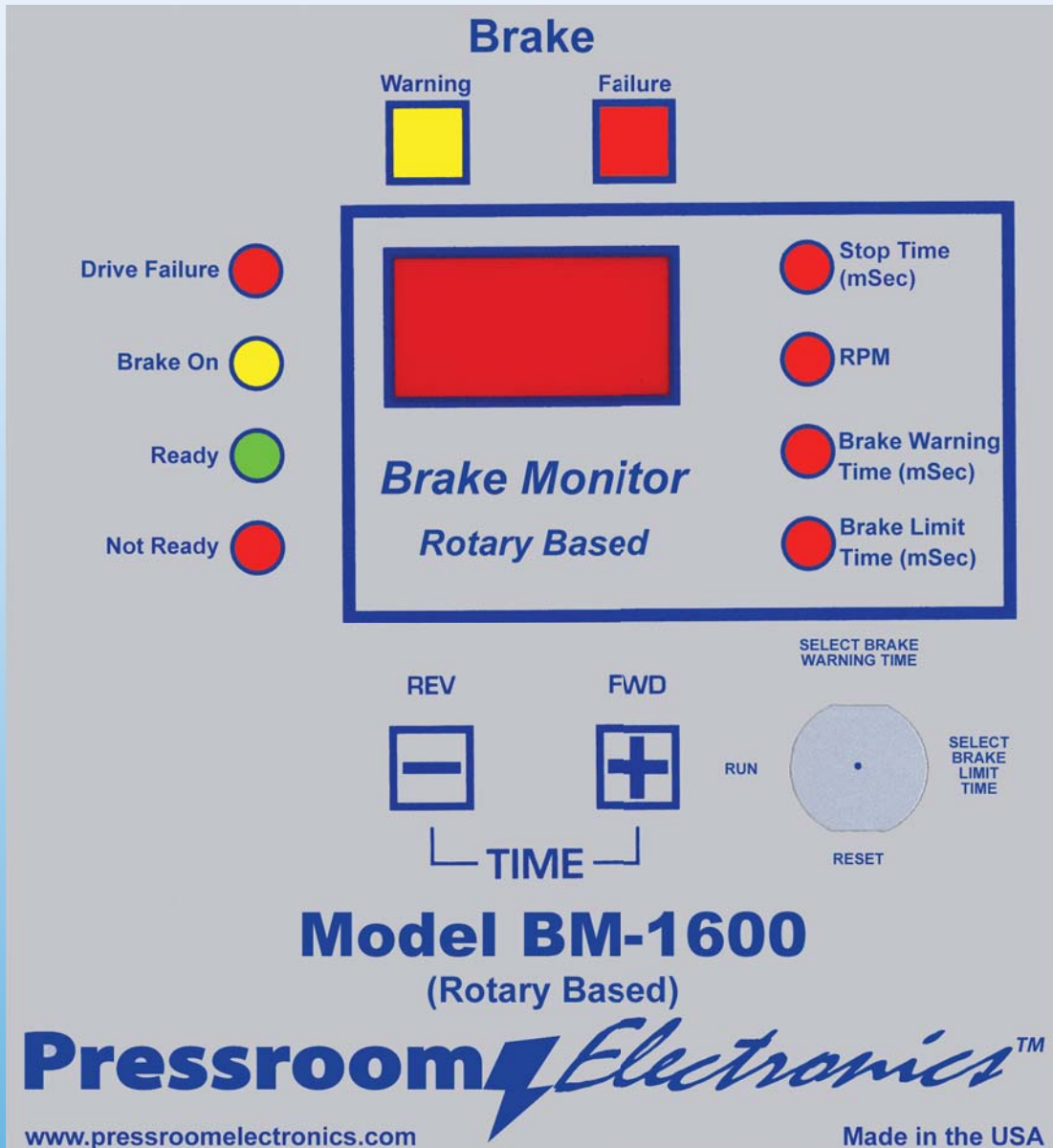



BM-1600 Rotary Time-Based Brake Monitor

Installation and Operation Manual

Pressroom Electronics, Inc.
3715 Swenson Avenue
St. Charles, IL 60174

P/N: 28-003r2-6

Customer Service: 630-443-9320 (CST)
(Please have Model #, Serial #, and Software Rev # Available)

Sales and Marketing: 800-937-4334 (EST)

Proper Use and Limitations

The BM-1600 Brake Monitor is critical for monitoring brake performance. Repairs should only be made by factory authorized personnel. The manufacturer cannot be held responsible for your repair attempts or the unit's subsequent safe operation.

As the BM-1600 Brake Monitor is a single function device, that of determining press stopping times while simultaneously determining that it is capable of just that, any internal malfunction will cause the unit to shut down. We will not supply individual component parts of any circuit board but will supply the individual circuit board complete.

The information disclosed herein includes proprietary rights of the manufacturer. Neither this document nor the information disclosed herein shall be reproduced or transferred to other documents or used or disclosed to others for manufacturing purposes, or for any other purposes, except as specifically authorized in writing by the manufacturer. If this manual is supplied in connection with the sale or delivery of manufacturer's equipment, it is to be used solely for maintenance, repair or installation of such equipment.

Warranty

Manufacturer warrants that this product will be free from defects in material and workmanship for a period of twelve months from the date of shipment thereof. Within the warranty period, manufacturer will repair or replace such products which are returned with shipping charges prepaid and which will be disclosed as defective upon examination by the manufacturer. This warranty will not apply to any product which will have been subject to misuse, negligence, accident, restriction and use not in accordance with manufacturer's instructions or which will have been altered or repaired by person's other than the authorized agent or employees of the manufacturer.

Disclaimer

The provisions of the paragraph "Warranty" are the sole obligations of the manufacturer and exclude all other warranties of merchantability, expressed or implied. Further, there are no warranties which extend beyond the above warranty.

Limitation of Liability

In the event of any claim for breach of any obligations of manufacturer under any order, whether expressed or implied, and particularly in the event of any claim of a breach of the warranty or warranties contained in the paragraph "Warranty" or of any other warranties, expressed or implied, which might despite the paragraph entitled "Disclaimer", be determined to be incorporated in any order, the company shall under no circumstances be liable for any consequential or special damages, either in law or in equity, or for losses or expenses or claims for the same arising from the use of, or inability to use, the products of the manufacturer for any purpose whatsoever.

We have designed our equipment to the very highest performance and safety standards known to the current technological state of the art. However, the installation, usage, suitability, and fitness of our equipment for any purpose, known or unknown, is interdependent upon the performance of other equipment not manufactured, installed, or secured or maintained by manufacturer.

We cannot and do not accept responsibility for any overall system performance when factors, such as these, are beyond our control.

WARNING: The entire machine safety system must be tested at the start of every shift. Machine testing should include: (1) proper machine operation and stopping capability; and (2) verification of proper installation and settings of all point of operation guards and devices before the operation is released for production.

Table of Contents

| | |
|--|------|
| Overview | 1 |
| Specifications | 2 |
| Installation | 3 |
| Adjusting the Set-Points | |
| Drive Failure..... | 4 |
| 90° Down from Top Stop Test..... | 4 |
| 270° Down from Top Stop Test..... | 4 |
| Stop Time Warning and Failure..... | 4 |
| Storing New Set-Point Values..... | 4 |
| Reset..... | 4 |
| Operation | |
| Starting the Press | 5 |
| Stopping the Press..... | 5 |
| Motion Detection | 5 |
| Safety Distance Calculation | 6 |
| Appendix A: Standards and Requirements | |
| ANSI Standard B11.1-2009..... | AA-1 |
| ANSI Standard Requirements..... | AA-1 |
| OSHA Standard Requirements | AA-2 |
| Appendix B: Definitions and Display Codes | |
| Indicator Definitions | AB-1 |
| Display Codes..... | AB-1 |
| Appendix C: Dimensions and Diagrams | |
| Cabinet Mounting..... | AC-1 |
| Encoder Mounting..... | AC-1 |
| Panel Cut-Out Dimensions | AC-2 |
| Wiring..... | AC-3 |
| Terminal layout for Boards prior to 2014 | AC-3 |
| Terminal layout for Boards after 2014 | AC-4 |

Pressroom 
Electronics TM

www.pressroomelectronics.com

The BM-1600 Brake Monitor is designed to measure speed from 0 to 999 SPM and stop time from 0 to 999 milliseconds each time the brake on the mechanical power press is applied. Set-points for Drive Failure, Brake Failure and Brake Warning are all stored along with the last occurring error in nonvolatile memory. A microcontroller, three watchdog timers, and two captive contact output relays assure control reliability.

All control and timing is done using the microcontroller. The watchdog timers assure that if the microcontroller fails, the relay contacts will always open. Dual captive contact relays assure that if a contact welds or one relay gets stuck closed, the other relay will automatically shut down and open up the remaining relay contact. The press Emergency Stop Circuit should be connected in series with the Brake Monitor relay contacts to allow the Brake Monitor to shut down the press if the brake fails to stop the press in the required time limit. Nonvolatile memory records any errors that occurred until they are reset using the keyswitch.

The encoder is used to detect speed and motion of the press by sending pulses to the Brake Monitor controller where the number of pulses per millisecond relates linearly to the speed of the press.

The Brake Monitor meets requirements of the ANSI Standard B11.1-2009 for time brake monitors as well as OSHA 1910.217b(14).

Care must be taken when installing the Brake Monitor to provide easy access to the Brake Monitor controller and assure that the cable connecting it to the encoder will not be crushed or damaged in any way.

Refer to ANSI Standard B11.1-2009 for information on setpoints and safety distances (see *Appendix A: Standards and Requirements, page AA-1*).

Specifications

BM-1600 Brake Monitor

| | | |
|-------------------------------|---|--|
| Controller | | |
| Power: | Standard: | 120 +/- 10% VAC, 50-60hz, 8 Watts |
| | Optional: | 240 +/- 10% VAC, 50-60hz, 8 Watts |
| | Optional: | 24 +/- 10% VDC, 8 Watts |
| Relay Configuration: | Dual self-checking force-guided captive contact safety relays | |
| Relay Contact Rating: | 8 amps @ 250VAC resistive for safety relays 4 amps @ 250VAC resistive for alarm relay | |
| System Accuracy: | +/- 1 millisecond | |
| Set Points: | Drive failure: | 1 to 25 tenths of a second |
| | Brake warning: | 1 to 999 milliseconds |
| | Brake failure: | 1 to 999 milliseconds |
| Display: | Speed: | 0 to 290 +/- 1 SPM 291 to 999 +/- 4 SPM |
| | Stop time: | 0 to 999 +/- 1 msec. |
| Indicators: | Brake Fault – Red LED Brake Warning – Yellow LED Drive Failure – Red LED Brake ON – Yellow LED Ready – Green LED Not Ready – Red LED Stop Time Display – Red LED SPM – Red LED Brake Warning Setpoint – Red LED Brake Limit Setpoint – Red LED | |
| Inputs: | Encoder: | see below |
| | Clutch: | 120 +/- 10% VAC |
| Output Circuit: | Two captive contact self-checking N.O. relays in series. Isolated (DRY) Normally open contacts -- -- -- Alarm relay will close when a warning or failure setpoint is exceeded. | |
| Operating Temperature: | 0° to 50° C | |
| Enclosure: | Lockable NEMA 12 steel | |
| Enclosure Dimensions: | 8" (203mm) Height x 7" (178mm) Width x 4" (127mm) Depth | |

| | | |
|---|---|--|
| Encoder (Part #E-160 — CW or CCW Rotation Capable) | | |
| Cable: | 20' (6m) is supplied standard; 100' (2540mm) maximum length. Gauge: 20 AWG – 3 connectors plus drain Rating: 300 VAC @ 60 C | |
| Shaft Loading: | Radial: 35 lbs. Axial: 40 lbs | |
| Operating Temp.: | 0° to 50° C | |
| Dimensions: | 5.5" (140mm) Height x 3.75" (95mm) Width x 3-9/16" (90mm) Depth | |
| Warranty: | 1 year | |

WARNING: The entire machine safety system must be tested at the start of every shift. Machine testing should include: (1) proper machine operation and stopping capability; and (2) verification of proper installation and settings of all point of operation guards and devices before the operation is released for production.

- 1) The bottom of the Brake Monitor has two 1/2" conduit size holes punched in it. The right punch-out will provide for AC power, brake solenoid signal, and emergency stop circuit lines. The left punch-out is used for the encoder cable only. **Do not run the encoder cable in the same punch-out hole as the high voltage lines.**
- 2) Mount the Brake Monitor controller box in a visible location.
- 3) Mount the motion detector to the main drive shaft by chain, or direct coupling for a 1:1 turning ratio. If the unit is to be chain driven, care must be taken not to exceed the load limits of the motion detector (see *Specifications, page 3*).
- 4) Dress the encoder cable around the press, but **keep the cable away from noise generating devices and high current carrying power lines to prevent the Brake Monitor from picking up noise.**

Supplied standard is 20' of shielded cable, however, the maximum length that can be used is 100' and you may shorten the cable to any length under 100'.

Connect the encoder cable wires to their proper terminals on both ends:

| Wire Color | Main Enclosure | Encoder Box |
|------------|----------------|-------------|
| RED | 3 | VCC (+5V) |
| BLACK | 4 | GROUND |
| CLEAR | 5 | DATA |
| BARE | 6 | SHIELD |

- 6) Tap off the wire going to your clutch (in parallel) and run this wire to Terminal 9 of the main enclosure. If your clutch uses a voltage other than 120VAC, you must have your Brake Monitor modified to handle this voltage. You should have 120VAC on Terminal 9 when the press is moving and OV when it is stopped. (See *Appendix C: Dimensions and Diagrams, page AC-2*).
- 7) **Connect the Emergency Stop Circuit to the Output Relay Contact Terminals 7 & 8 so that the Brake Monitor can control the Stop Circuit.**
- 8) Connect power to the circuit through Terminals 10 G, 11 N, and 12 L.
- 9) Read ANSI Standard B11.1-2009 for guidelines on how to determine brake limit setpoints and safety distances (see *Appendix A: Standards and Requirements, page AA-1*).
- 10) Run a series of 90deg Stop Tests with your heaviest die. This will give you a largest, longest Stop time. You then need to determine your acceptable Distance away from the pinch point (Hazard) and acceptable Brake wear. Consult your Press owner's manual and ANSI Standard B11.1-2009 to come up with a Warning and LIMIT (Fail) setpoints. The LIMIT (Fail) setpoint is the value you use in the ANSI Safety Distance Formula, because the BM-1600 will not shut down your Press until you exceed the LIMIT (Fail) setpoint. The Safety Distance calculation (see page 6) determined by the BM-1600, only refers to the current Stop Time and not the LIMIT (Fail) Setpoint. The Safety Distance calculation value is used to show you the total Stop time of your system: From light curtain to Press control to Brake.

WARNING: The LIMIT (Fail) setpoint value you select is what you must use in the ANSI Safety Distance Formula. Do NOT use the current (Displayed) Stop time in the ANSI Safety Distance Formula.

Adjusting the Set-Point

BM-1600 Brake Monitor

Drive Failure

Description: When 120VAC is applied to the clutch input (indicating that the brake has been released) the Brake Monitor will de-energize its safety relays and issue a C8 error code if it does not see motion of the press within the Drive Failure Set-Point delay period. This detects a chain break, faulty wiring, or bad encoder.

At what value should it be set? This set-point should be set as low as possible, but higher than the time it takes for the press to start moving. Initially the delay is set to 5 which equals .5 seconds. If this value is too high, the press could completely cycle without ever detecting the Drive Failure.

To change set-point:

- a) Turn the keyswitch to "Select Brake Warning Time."
- b) Push both the REV and FWD keys until the "Brake Warn Time" LED indicator turns off.
- c) The display now shows drive failure delay time in tenths of seconds (i.e., 10 = 1.0 seconds).
- d) Select a new value using the REV and FWD push buttons. When the keyswitch is turned, the new value is stored.

90° Down from Top Stop Test

Description. This test is to determine the worst case stopping time for your press and is used in determining the press stop time used in the safety distance formula. The test allows the press to rotate 90° then automatically stops it. Refer to ANSI Standard B11.1-2009 (see *Appendix A: Standards and Requirements, page AA-1*).

To run test.

- a) Place the press at top stop, turn keyswitch to "Select Brake Limit Time" and press the REV and FWD keys until the digital display shows C6.
- b) Move the keyswitch back into the RUN position and cycle the press.
- c) The Brake Monitor will open its relay contacts when the press travels 90° from top stop then, automatically, computes the stop time.

270° Down from Top Stop Test

Description. The brake monitor will allow the press to travel 630° which is 1-3/4 times around. The press will start to stop at the 270° mark. This is used to check for proper counter balance.

To Run Test. Simply go into the 90° test and hit the "+" key to change the display from C6 to C11, then follow steps B and C of the 90° test.

Stop Time Warning and Failure

Description. When 120VAC is removed from the clutch input (brake applied), the brake monitor will determine how long it takes for the press to come to a complete stop.

- a) If the actual stop time exceeds the warning set-point, then the amber warning light will come on to indicate that you are getting close to the failure set-point.
- b) If the actual stop time exceeds the failure set-point, then the red failure light will come on and the safety relays will de-energize and shut down the press from further cycles until you clear the error.

What value should it be set? Read ANSI Standard B11.1-2009 before going any further (see *Appendix A: Standards and Requirements, page AA-1*). The failure set-point is used in the safety distance formula; the larger the value, the further you will have to place your guards from the pinch point, but you won't have to replace the brake as often.

To change set-point:

- a) Turn the keyswitch to the "select brake warning time" position.
- b) Select a new warning set-point using the REV and FWD push buttons.
- c) Turn the keyswitch to the "select brake limit time" position.
- d) Select a new failure set-point.
- e) Turn the keyswitch back to "run."

Storing New Set-Point Values

When the keyswitch is moved back into the "run" position, the new settings are permanently stored in nonvolatile memory and does not require a battery.

Reset

Use the "reset" position to clear faults when they occur. Reset will not reset set-points.

Starting the Press

- a) The Brake Monitor receives a 120VAC signal from the Clutch Input (Terminal 9) to signal that the brake has been released.
- b) If no motion is detected by the Brake Monitor within the Drive Failure set-point time the Brake Monitor shuts down and issues a C8 error code. The error code will be recorded into permanent memory.
- c) If motion was detected, the display will show SPM until the brake is reapplied.

Stopping the Press

- a) The Brake Monitor no longer detects 120VAC present on the Clutch Input (Terminal 9). This indicates that the brake is now reapplied.
- b) The internal Brake Monitor timer starts to count in 1 millisecond increments.
- c) The display shows the accumulating stop time rising.
- d) If the current stop time exceeds the warning set-point, then the amber warning light will turn on, but no error will have occurred.
- e) If the current stop time exceeds the failure set-point, then the amber warning light will turn off and the red failure light will turn on. The final stop time will be recorded into permanent memory along with the failure code.
- f) If the final stop time is less than the failure set-point by more than 80%, then the amber warning light will come on and an error code of C10 will be issued, but not recorded. This indicates that the actual press stopping time is too low compared to the set-point. This may indicate a faulty encoder or that someone has tampered with the set-point by raising it up to prevent shut downs.
- g) The final stop time will be displayed until the next cycle starts.

Motion Detection

If the press moves and the Brake Monitor did not get the 120VAC Clutch Input signal, the Brake Monitor will shut down and turn on both the amber warning and red failure lights. An error code C7 will be issued to permanent memory and may indicate incorrect wiring.

Safety Distance Calculation

BM-1600 Brake Monitor

Safety Distance Calculation

Description: Safety Distance is the separation (in inches) between the hazardous point of operation and the guarding device (i.e., light curtain). Your guarding device manual will contain a formula to calculate this distance. You need to know the total response time of your system (the time from a body part blocking the guard to the total cessation of motion).

The BM-1600 can calculate Safety Distance based on the ANSI Standard B11.1-2009 formula.

With Light Guard: Wire 120VAC LINE through the N.O. Auxiliary Output of your light guard to Terminal 13 of the BM-1600. Wire NEUTRAL to Terminal #14 of the BM-1600. You should have 120VAC across Terminal #13 - #14 when the guard is GREEN (not blocked) and 0V when the guard is RED (blocked).

Without Light Guard: Wire 120VAC LINE to Terminal #13 of the BM-1600 and Neutral to Terminal #14.

NOTE: If you do not want the stop time to reflect the Press control response time, do not put any voltage across Terminals #13 and #14

To Run Test: Put BM-1600 into 90° or 270° stop test mode. Start the press (then block guard if you have one). The stop time is computed from the guard blockage (or end of test) to the cessation of motion.

The BM-1600 will add 35mSec (guard response time) to the total response time, if you block the guard during the test. If you do not have a guard, Start the press and let the BM-1600 end the test. The BM-1600 will not add any additional time.

Safety Distance can be read (in inches) by pushing and holding the + or - key on the front panel (the Stop Time LED will dim to let you know your viewing distance).

NOTE: If the Stop time exceeds the FAIL setpoint, you will not be able to view distance. You will have to temporarily raise the FAIL setpoint for this test.

NOTE: If you fail to block the guard before the test is over, you will be viewing the stop time that includes the time it took for the Press control to respond to the BM-1600 but not the guard response time.

IMPORTANT NOTE: The default Depth Penetration Factor (Dpf) is set to 2". Your light Guard manual will instruct you on what your Dpf is. If it is larger, you must add the additional amount. (I.E. Dpf is 5, then you must add an additional 3" to the safety distance displayed)

Formula: Safety Distance displayed equals 64 inches/sec * (35msec guard response time + total BM-1600 detected time msec) + DPF of 2"

IMPORTANT NOTE: This Safety Distance Calculation does not take into account the FAIL set-point. As the break wears, the stop time will increase until it reaches the FAIL setpoint (limit). This will increase the Safety Distance if the FAIL setpoint is larger then the actual stop time.

ANSI Standard B11.1-2009

The total stopping time of the press should include the total response time of the control system and the time it takes the press to cease slide motion. The following formula should be used when calculating the safety distance (D_s):

$$D_s = K(T_s + T_c + T_{bm})$$

Where:

K = 63 inches/second (hand speed constant).

T_s = the stop time of the press measured from the final de-energized control element, usually the air valve.

T_c = the response time of the control.

T_{bm} = the additional time allowed by the brake monitor before it detects stop time deterioration.

NOTE - T_s + T_c are usually measured by a stop time measuring device.

When the press stopping-performance monitor timer or STOP position sensor is changed, the safety distance should be recalculated.

American National Standards Institute Standard Requirements

ANSI B11.1-2009 Safety Requirements for Mechanical Power Presses

ANSI B11.2-1995 (R2000) Hydraulic Power Presses - Safety Requirements for Construction, Care and Use

ANSI B11.3-2002 Safety Requirements for Power Press Brakes

ANSI B11.4-2003 Safety Requirements for Shears

ANSI B11.5-1988 (R2002) Iron Workers - Safety requirements for Construction, Care and Use

ANSI B11.6-2001 Safety Requirements for Manual Turning Machines

ANSI B11.7-1995 (R2000) Cold Headers and Cold Formers - Safety Requirements for Construction, Care and Use

ANSI B11.8-2001 Safety Requirements for Manual Milling, Drilling and Boring Machines

ANSI B11.9-1975 (R1997) Grinding Machines - Safety Requirements for Construction, Care and Use

ANSI B11.10-2003 Metal Sawing Machines - Safety Requirements for Construction, Care and Use

ANSI B11.11-2001 Safety Requirements for Gear & Spline Cutting Machines

ANSI B11.12-1996 Roll Forming and Roll Bending Machines - Safety Requirements for Construction, Care and Use

ANSI B11.13-1992 (R1998) Automatic Screw/Bar and Chucking Machines - Safety Requirements for Construction, Care and Use

ANSI B11.14-1996 Coil Slitting Machines - Safety Requirements for Construction, Care and Use

ANSI B11.15-2001 Safety Requirements for Pipe, Tube and Shape Bending Machines

ANSI B11.17-1996 Horizontal Hydraulic Extrusion Presses - Safety Requirements for Construction, Care and Use

ANSI B11.18-1997 Coil Processing Systems - Safety Requirements for Construction, Care and Use

ANSI B11.20-1991 (R1996) Manufacturing Systems / Cells - Safety Requirements for Construction, Care and Use

ANSI B11.21-1997 Machine Tools Using Lasers - Safety Requirements for Construction, Care and Use

ANSI B11.22-2002 Safety Requirements for Numerically Controlled Turning Machines

ANSI B11.23-2002 Safety Requirements for Machining Centers

ANSI B11.24-2002 Safety Requirements for Transfer Machines

ANSI B11.TR1-1993 Ergonomic Guidelines for the Design, Installation and Use of Machine Tools

ANSI B11.TR2-1997 Mist Control Considerations for the Design, Installation and Use of Machine Tools Using Metalworking Fluids

ANSI B11.TR3-2000 Risk Assessment and Risk Reduction - A guide to estimate, evaluate and reduce risks associated with machine tools

Appendix "A"

Standards and Requirements

Occupational Safety and Health Administration (OSHA)

29 CFR Part 1910 Subpart O

Machinery and Machine Guarding

1910.211 - Definitions.

1910.212 - General requirements for all machines.

1910.213 - Woodworking machinery requirements.

1910.214 - Cooperage machinery. [Reserved]

1910.215 - Abrasive wheel machinery.

1910.216 - Mills and calenders in the rubber and
plastics industries.

1910.217 - Mechanical power presses.

1910.217 - (Appendix A) Mandatory requirements for
certification/validation of safety systems
for presence sensing device initiation of
mechanical power presses

1910.217 - (Appendix B) Nonmandatory guidelines
for certification/validation of safety
systems for presence sensing device
initiation of mechanical power

presses

1910.217 - (Appendix C) Mandatory requirements for
OSHA recognition of third-party validation
organizations for the PSDI standard

1910.217 - (Appendix D) Nonmandatory
supplementary information

1910.218 - Forging machines.

1910.219 - Mechanical power-transmission
apparatus.

Indicator Definitions

Brake Warning. Press stopping time exceeded the warning set-point but not the limit set-point. The relay contacts remain closed and the unit does not need to be reset.

Brake Failure. Press stopping time exceeded the limit set-point. The relay contacts open and the unit must be reset.

Drive Failure. No motion was detected within the set-point time (initially .5 sec) by the Brake Monitor when the brake was released. A C8 error code is also displayed.

Brake On. Directly linked to the 120VAC Clutch Input. This LED is off when the 120VAC signal is present indicating the brake is released.

Ready. Directly linked to the captive contact output relays to indicate that the circuit is closed.

Not Ready. Directly linked to the captive contact output relays to indicate that the circuit is open which indicates that either the keyswitch is in the reset position or a failure occurred.

Stop Time (msec). Indicates that the digital display is showing the press stopping time in milliseconds.

SPM. Indicates that the digital display is showing the press speed in revolutions or strokes per minute.

Brake Warn Time. Indicates that the digital display is showing the select warning time set-point. This means you can change the warning set-point time.

Brake Limit Time. Indicates that the digital display is showing the select limit time set-point. This means you can change the failure set-point time.

Display Codes

C1 Stop Circuit Relay(s) On, Should Be Off

Cause(s): a) Relay contact may be welded.
b) Relay drive circuit may be faulty.

Cure(s): Push nylon tie-wraps out of the way and remove both relays (do not cut the tie-wraps).

a) Check relay contacts for scoring or pitting. If so, check the circuit that the Brake Monitor is in series with for current draw. Do not exceed half the relay rating. If you see a spark on the relay contact when the relays energize or de-energize, then you are drawing too much current through the relay contacts. Try placing a MOV across the terminals of any relay coils that are energized by this circuit.

b) Also, check for bad solder joints or shorts on the bottom of the board holding the relays.

C2 Stop Circuit Relay(s) Off, Should Be On

Cause(s): a) Relay drive circuit may be faulty.
b) VAC line voltage may be low.

Cure: Check solder joints, relays, and line voltage.

C 3 Failure in EEPROM (nonvolatile memory)

Cause(s): a) VAC line voltage may be low.
b) Bad EEPROM.

Cure: Check line voltage. May require new EEPROM.

C 4 EEPROM Needs to be Initialized

Cause: After a C3 error code, the computer tries to initialize the EEPROM over and over until it takes.

Cure: Computer will automatically try to reprogram chip.

Appendix "B"

Definitions and Display Codes

C 5 Internal RAM Fault in Microprocessor

Cause: Ram integrity test failed.

Cure: Shut off power for 1 minute and try again. May require a new microprocessor chip.

C 6 90° Mode Selected

The Brake Monitor will allow the press to travel only 90° from its starting point and compute a stop time.

Cause: The keyswitch was moved into the select brake limit position and both REV and FWD keys were pushed simultaneously.

Cure: Cycle the press.

C 7 Motion Detected While Press Stopped

Cause: Brake Monitor did not get Clutch Input signal and press moved.

Cure(s):

- Check clutch solenoid connections
- Check encoder mounting and coupling.
- Tighten chain or belt.
- Place MOV devices on power terminals of nearby motors, solenoids, etc.

C 8 Drive Failure (no signal from encoder)

The computer received a 120VAC signal from the Clutch Input telling it to expect the press to start moving; after an initial waiting period (from .1 to 2 seconds) the computer shut downs because it did not receive any signal back from the encoder to indicate that the press did move.

Cause(s):

- Encoder cable hooked up wrong.
- Faulty encoder.
- Drive Failure set-point too low.
- Encoder not linked to main drive shaft.
- Main drive shaft not turning.
- Faulty clutch signal.

Cure: Check the "brake on" yellow LED

on the front panel, it should be off only when you initiate the press. If it is off at any other time, then the Clutch Input is not hooked up to the clutch.

If the press did not have a chance to move before the error occurred, then you must change the Drive Failure set-point (see *Adjusting the Set-Points, page 4*). Check the encoder cable wiring on both ends.

C 9 Keyswitch in Reset

This will remove any error code(s) from memory and erase the last stop time.

Cause: Keyswitch was moved from the "run" position into the "reset" position.

Cure: Place keyswitch back into "run" position.

C11 270° Mode Selected

The Brake Monitor will allow the press to travel 630° which is 1-3/4 times around. The press will start to stop at the 270° mark. This is used to check for proper counter balance.

Cause: Hitting the "+" key while in C6 mode.

Cure: Cycle the press.

Cabinet Mounting

Dimensions

- A 7.00" (178mm) Width
- B 4.00" (102mm) Distance between holes on each side
- C 8.00" (203mm) Height
- D 4.00" (102mm) Depth
- 8.65" (220mm) Distance between holes top to bottom

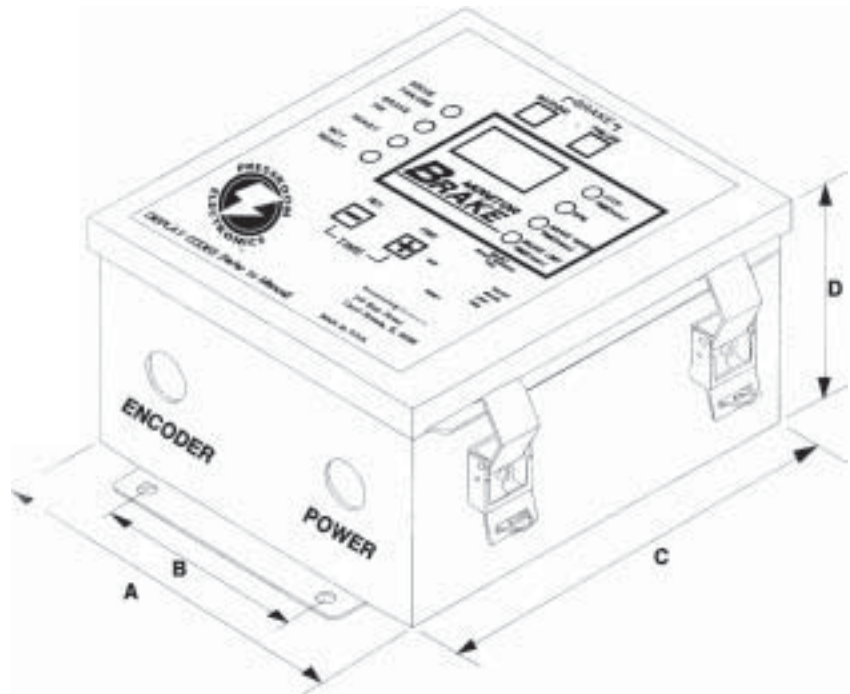

Encoder Mounting

(*) - Note: Shaft Diameter prior to 9/1/2014 is 1/2"

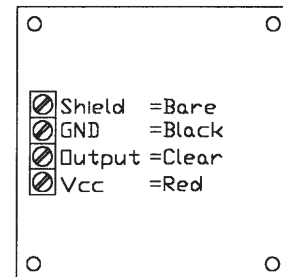
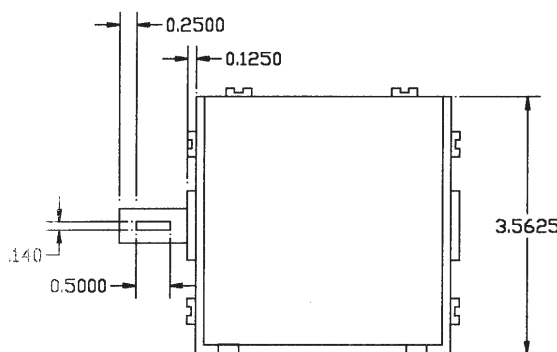
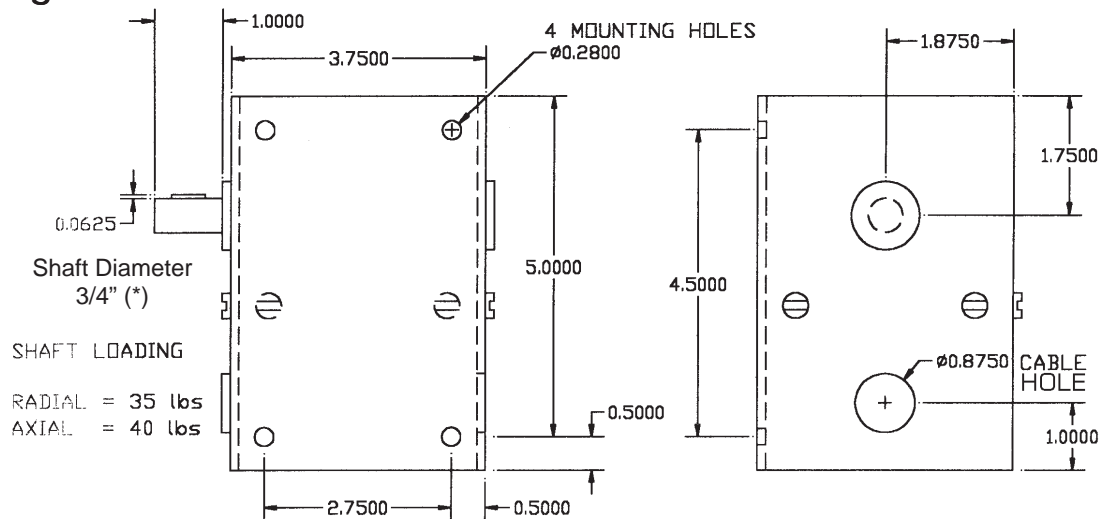

REV Date 04/12/94

Appendix "C"

Dimensions and Diagrams

Panel Cut-Out Dimensions (#11-073)

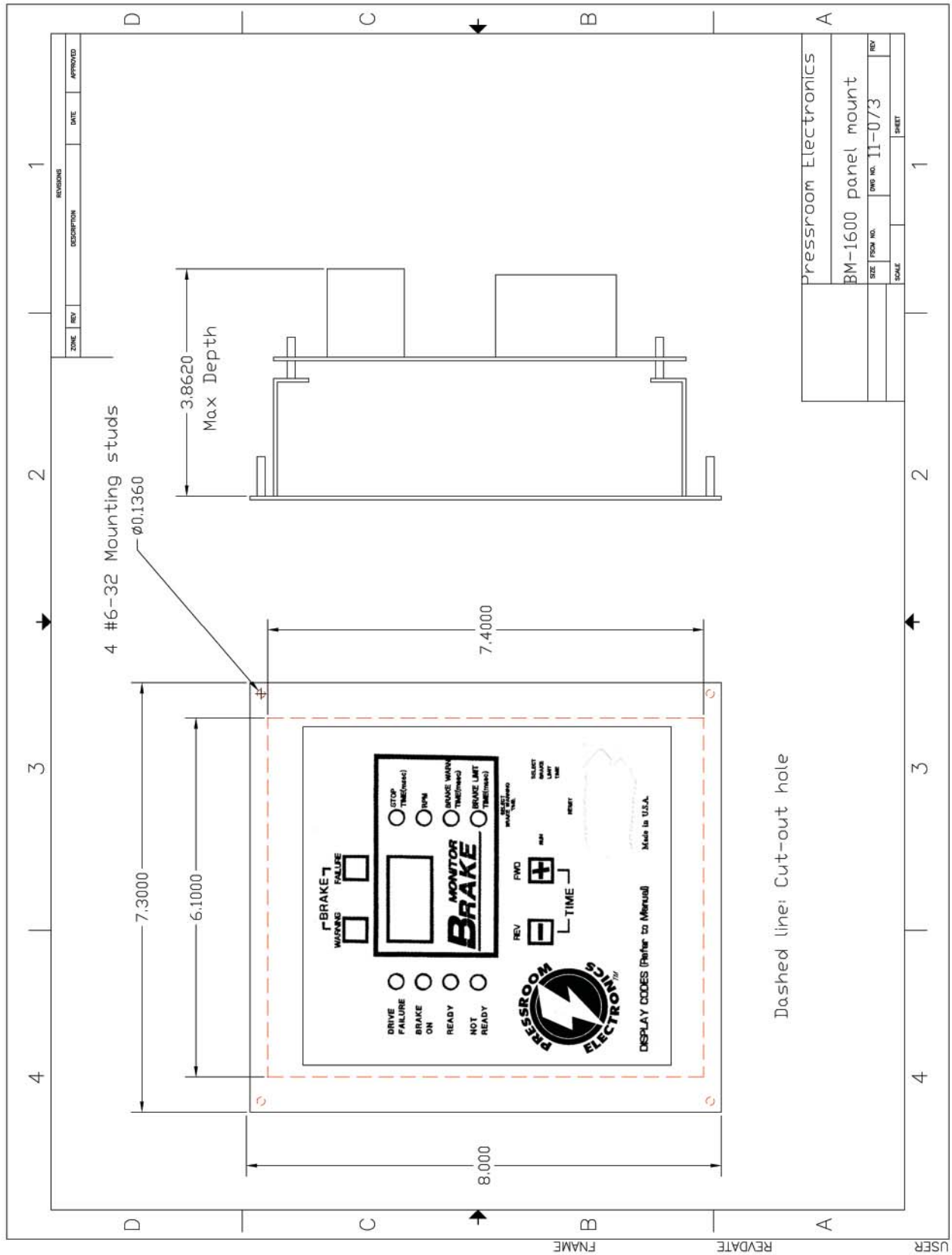

Wiring

| Terminal | Label | Definition |
|-------------|----------------------|--|
| 1,2 | ALARM | N.O. dry contact closes when error occurs, during a stop time warning, or stop time failure. N.O. |
| 3 | +5V | Supply voltage to encoder. |
| 4 | GND | Supply ground to encoder. |
| 5 | DTA | Data line from encoder to brake monitor. |
| 6 | SHIELD | Electrical shield for encoder cable. |
| 7-8 & 15-16 | SAFETY | Two captive contact safety relays in series forming a N.O. dry output contact for use in series with your stop circuit. |
| 9 | CLUTCH | 120VAC input signal coming from your clutch to signal when it is disengaged (tells the brake monitor that the press should start moving). |
| 10 | EARTH | Earth ground (to case). |
| 11 | N | Neutral side of 120VAC / 240VAC. |
| 12 | L | Line side of 120VAC / 240VAC. |
| | | NOTE: If you have the 24VDC option (no transformer), then Terminals 11 and 12 are used as your +/- terminals. These terminals are non-polarized so you can hook up power in either direction (+ - or - +). |
| 13,14 | LIGHT GUARD | Used to check system response time. See "Safety Distance Calculation" section for wiring. |
| | INCH MODE (optional) | 110VAC across Terminals 13 and 14 will increase stop time setpoints by 25% to prevent accidental tripping out the brake monitor during setup. |

Below is the Terminal layout for boards prior to 2014. See page AC-4 for current Terminal layout.

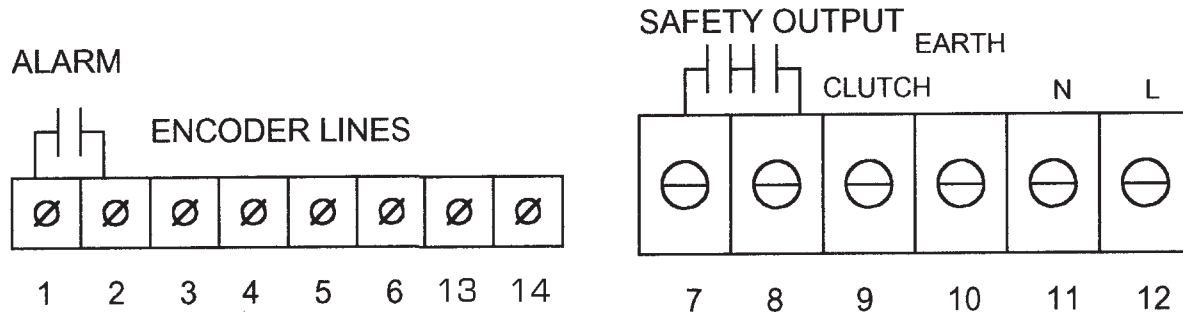

WARRANTY

Manufacturer warrants that this product will be free from defects in material and workmanship for a period of one year from the date of shipment thereof. Within the warranty period, manufacturer will repair or replace such products which are returned to it with shipping charges prepaid and which will be disclosed as defective upon examination by the manufacturer. This warranty will not apply to any product which will have been subject to misuse, negligence, accident, restriction, and use not in accordance with manufacturer's instructions or which will have been altered or repaired by persons other than the authorized agent or employees of the manufacturer.

DISCLAIMER

The provisions of the paragraph "Warranty" are the sole obligations of the manufacturer and exclude all other warranties of merchantability, expressed or implied.

Further, there are no warranties which extend beyond the above warranty.

LIMITATION OF LIABILITY

In the event of any claim or breach of any obligations of manufacturer under any order, whether expressed or implied, and particularly in the event of any claim or a breach of the warranty or warranties contained in the paragraph "Warranty" or of any other warranties, expressed or implied which might, despite the paragraph entitled "Disclaimer," be determined to be incorporated in any order, the company shall under no circumstances be liable for any consequential or special damages, either in law or in equity, or for losses or expenses or claims for the same arising from the use of, or inability to use, the products of the manufacturer for any purpose whatsoever.

WARNING: The entire machine safety system must be tested at the start of every shift. Machine testing should include: (1) proper machine operation and stopping capability; and (2) verification of proper installation and settings of all point of operation guards and devices before the operation is released for production.



www.pressroomelectronics.com

Sales and Marketing Offices

United States

Pressroom Electronics, Inc.
P.O. Box 100088
Pittsburgh, PA 15233
Toll Free: 800-937-4334
Direct: 412-262-1115
Fax: 412-262-1197

Canada

Pressroom Electronics, Inc.
8-1734 Orangebrook Court
Pickering, Ontario L1W 3G8
Toll Free: 888-285-8885
Direct: 905-831-1111
Fax: 905-831-4064

Customer Service (630) 443-9320

We have designed our equipment to the very highest performance and safety standards known to the current technological state of the art, as evidenced by our U.S.A. and foreign patents issued and pending. However, the installation, usage, suitability, and fitness of our equipment for any purpose, known or unknown, is interdependent upon the performance of other equipment not manufactured, installed, secured or maintained by Pressroom Electronics, Inc.

We cannot and do not accept responsibility for any overall system performance when factors, such as these, are beyond our control.

www.pressroomelectronics.com

sales@pressroomelectronics.com
service@pressroomelectronics.com